

# Greenmood

---

## PRODUCT SPECIFICATION SHEET G-CIRCLES

1. MODELS
  2. FRAME FINISHES
  3. FILLINGS
- 

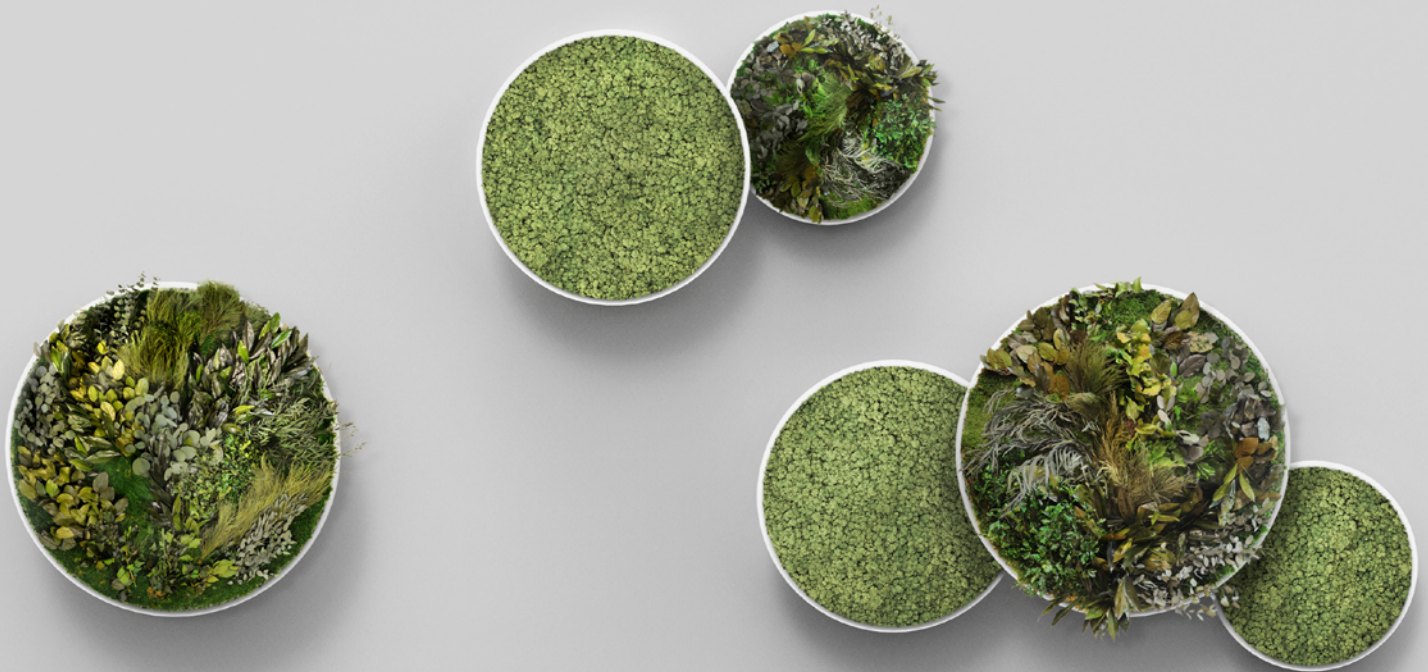

### 1. MODELS (Standard version – 3 sizes)

#### G-Circle SMALL

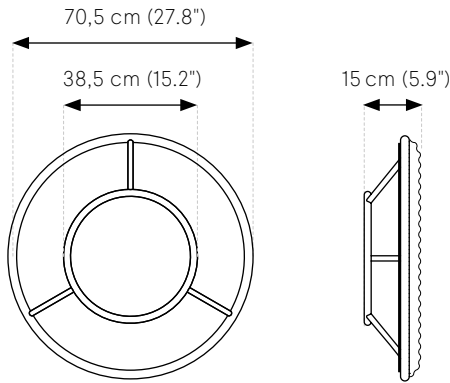

**Weight** – Gross weight (±15%): 7 kg (15 lbs)



**Materials** – Front Circle: Aluminium tube Ø 25 mm (1")  
Back Circle: Aluminium tube Ø 20 mm (3/4")  
Frame links: Aluminium tubes Ø 15 mm (5/8")  
Backing panel: Cork layer 3mm (1/8")



**Finishes** – Powder coatings: Matte White    Matte Grey  
   Matte Black    Matte Blue  
   Corten       Sparkling Green  
   Gold       Sparkling Burgundy  
                 Sparkling Red



**Fillings** – Reindeer Moss (Lichen)    Velvet Leaf  
   Ball Moss  
   Forest (Preserved plants)  
   Mirror  
   Magnetic Whiteboard

#### G-Circle MEDIUM

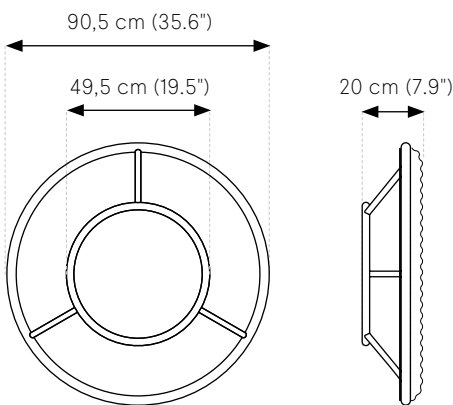

**Weight** – Gross weight (±15%): 12 kg (26 lbs)



**Materials** – Front Circle: Aluminium tube Ø 25 mm (1")  
Back Circle: Aluminium tube Ø 20 mm (3/4")  
Frame links: Aluminium tubes Ø 15 mm (5/8")  
Backing panel: Cork layer 3mm (1/8")



**Finishes** – Powder Coatings: Matte White    Matte Grey  
   Matte Black    Matte Blue  
   Corten       Sparkling Green  
   Gold       Sparkling Burgundy  
                 Sparkling Red



**Fillings** – Reindeer Moss (Lichen)    Velvet Leaf  
   Ball Moss  
   Forest (Preserved plants)  
   Mirror  
   Magnetic Whiteboard

#### G-Circle LARGE

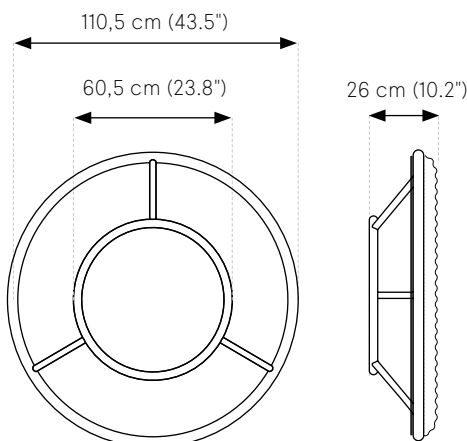

**Weight** – Gross weight (±15%): 16 kg (35 lbs)



**Materials** – Front Circle: Aluminium tube Ø 25 mm (1")  
Back Circle: Aluminium tube Ø 20 mm (3/4")  
Frame links: Aluminium tubes Ø 15 mm (5/8")  
Backing panel: Cork layer 3mm (1/8")



**Finishes** – Powder Coatings: Matte White    Matte Grey  
   Matte Black    Matte Blue  
   Corten       Sparkling Green  
   Gold       Sparkling Burgundy  
                 Sparkling Red



**Fillings** – Reindeer Moss (Lichen)    Velvet Leaf  
   Ball Moss  
   Forest (Preserved plants)  
   Mirror  
   Magnetic Whiteboard

### 1. MODELS (Slim versions - 3 sizes)

#### G-Circle SMALL "SLIM"

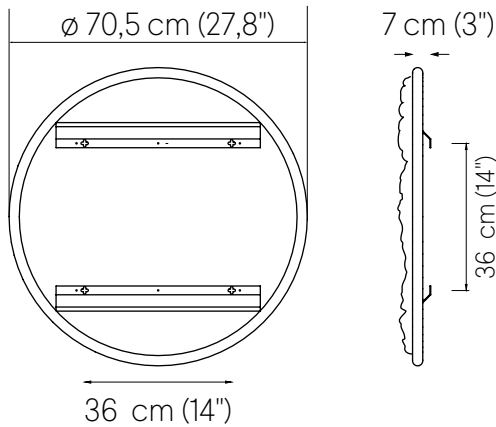

	<b>Weight</b>	— Gross weight (±15%): 6 kg (13 lbs)
	<b>Materials</b>	— Circle frame: Aluminium tube Ø 25 mm (1") Backing panel: Cork layer 3mm (1/8")
	<b>Finishes</b>	— Powder coatings: Matte White    Matte Grey Matte Black    Matte Blue Corten            Sparkling Green Gold                Sparkling Burgundy Sparkling Red
	<b>Fillings</b>	— Reindeer Moss (Lichen)    Velvet Leaf Ball Moss Forest (Preserved plants) Mirror Magnetic Whiteboard

#### G-Circle MEDIUM "SLIM"

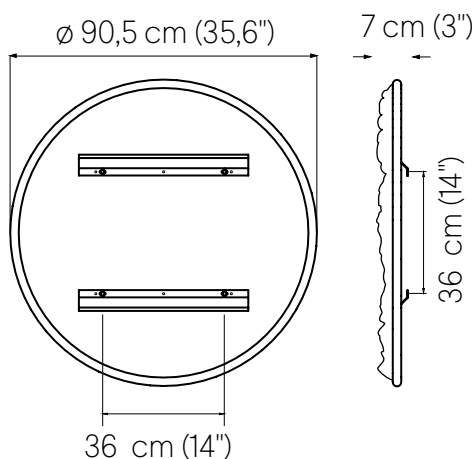

	<b>Weight</b>	— Gross weight (±15%): 11 kg (24 lbs)
	<b>Materials</b>	— Circle frame: Aluminium tube Ø 25 mm (1") Backing panel: Cork layer 3mm (1/8")
	<b>Finishes</b>	— Powder Coatings: Matte Grey Matte White    Matte Blue Matte Black    Sparkling Green Corten            Sparkling Burgundy Gold                Sparkling Red
	<b>Fillings</b>	— Reindeer Moss (Lichen)    Velvet Leaf Ball Moss Forest (Preserved plants) Mirror Magnetic Whiteboard

#### G-Circle LARGE "SLIM"

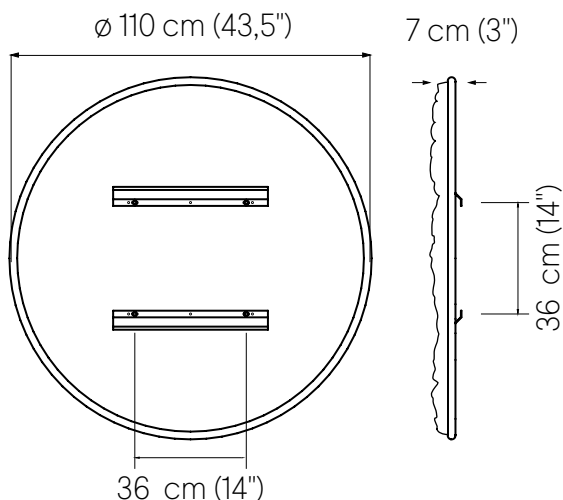

	<b>Weight</b>	— Gross weight (±15%): 15 kg (33 lbs)
	<b>Materials</b>	— Circle frame: Aluminium tube Ø 25 mm (1") Backing panel: Cork layer 3mm (1/8")
	<b>Finishes</b>	— Powder Coatings: Matte White    Matte Grey Matte Black    Matte Blue Corten            Sparkling Green Gold                Sparkling Burgundy Sparkling Red
	<b>Fillings</b>	— Reindeer Moss (Lichen)    Velvet Leaf Ball Moss Forest (Preserved plants) Mirror Magnetic Whiteboard

## 2. FRAME FINISHES



### MATTE WHITE Powder coating



	<b>Texture</b>	— Fine texture
	<b>Gloss Level</b>	— 20±5
	<b>Color</b>	— 9010

### MATTE BLACK Powder coating



	<b>Texture</b>	— Fine texture
	<b>Gloss Level</b>	— 20±5
	<b>Color</b>	— 9005

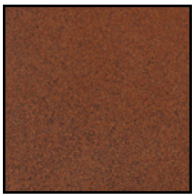

### CORTEN Powder coating

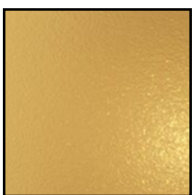

	<b>Texture</b>	— Coarse texture
	<b>Gloss Level</b>	— 10±5
	<b>Color</b>	— Not specified

### GOLD Powder coating



	<b>Texture</b>	— Smooth texture
	<b>Gloss Level</b>	— 80±5
	<b>Color</b>	— Not specified

### Matte Grey



	<b>Texture</b>	— Fine grainy
	<b>Gloss Level</b>	— MAT/FS
	<b>Color</b>	— 7032

## 2. FRAME FINISHES

### Sparkling Burgundy

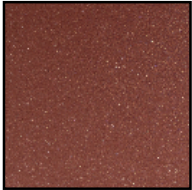

	<b>Texture</b>	— Fine grainy
	<b>Gloss Level</b>	— MAT/MFS
	<b>Color</b>	— Not specified

### Matte Blue

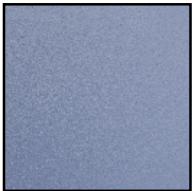

	<b>Texture</b>	— Fine grainy
	<b>Gloss Level</b>	— MAT/FS
	<b>Color</b>	— 5014

### Sparkling Red



	<b>Texture</b>	— Fine grainy
	<b>Gloss Level</b>	— MT/METF
	<b>Color</b>	— 3602

### Sparkling Green

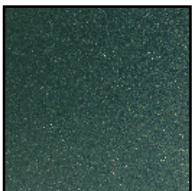



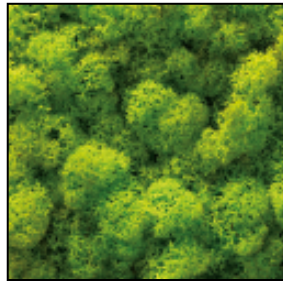
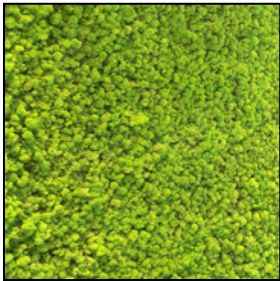

	<b>Texture</b>	— Fine grainy
	<b>Gloss Level</b>	— ME/METF
	<b>Color</b>	— 9010

## 3. FILLINGS (1/2)



### REINDEER MOSS (Lichen)



-  **Origin** – Handpicked in Europe (Scandinavia)
-  **Security** – Naturally Fire-retardant (ISO 11925-2, certificate available)  
Class: B-S2-d0
-  **Durability** – 100% Maintenance free (avoid direct sunlight)  
Keeps its form, color & texture for 7 to 10 years
-  **Health** – Non-toxic  
Non-allergen
-  **Colors** – Available in various colors

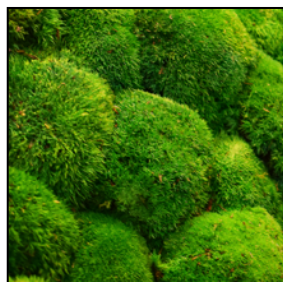
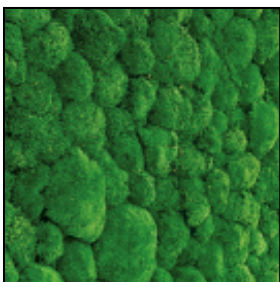

### BALL MOSS

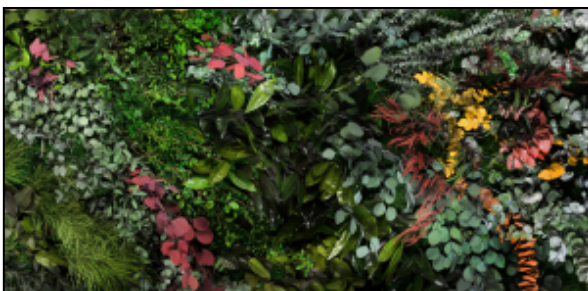

-  **Origin** – Handpicked in Europe
-  **Durability** – 100% Maintenance free  
Keeps its form, color & texture for 5 to 7 years  
(Avoid direct sunlight on the moss to preserve its color)
-  **Health** – Non-toxic  
Non-allergen

### FOREST (Custom handmade compositions using various foliage species on a flat moss background)





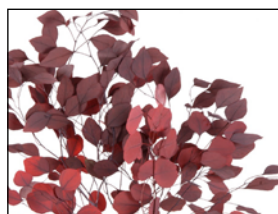

-  **Origin** – Various locations
-  **Durability** – 100% Maintenance free  
Keeps its form, color & texture for 5 to 7 years  
(Avoid direct sunlight on foliage to preserve their color)
-  **Health** – Non-toxic  
Non-allergen

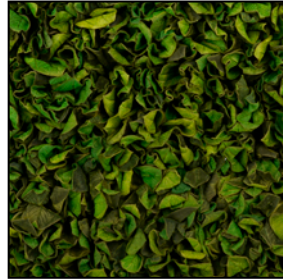

## 3. FILLINGS (2/2)

### VELVET LEAF



-  **Origin** — Handpicked in South America
-  **Durability** — 100% Maintenance free  
Keeps its form, color & texture for 5 to 7 years  
(Avoid direct sunlight on foliage to preserve its color)
-  **Health** — Non-toxic  
Non-allergen

### MIRROR

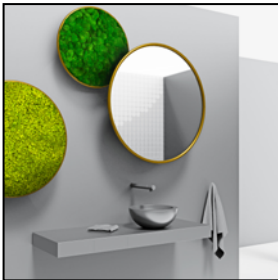

-  **Details** — High quality mirror inlaid in the structure  
(frame higher than mirror's surface)  
  
Thickness: 3 mm (0.12")

### MAGNETIC WHITEBOARD

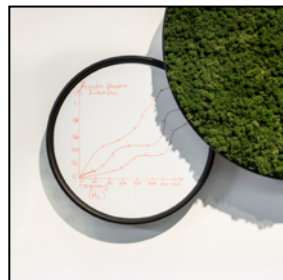
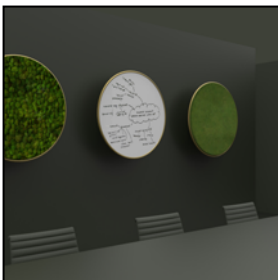

-  **Details** — Steel covered with high quality Dry-erase Whiteboard sheet  
  
Panel inlaid in the structure  
(frame higher than whiteboard's surface)  
  
Thickness: 1mm (0.04")